



LED Spot Fresh Food Track Light HQ

Technical Specifications	
On / Off Cycles	50,000
Colour Consistency (SDCM)	6
Dimmable	No
Finishing Colour	White
IP	IP20
Driver Integrated (Yes/No)	Yes
Glow Wire Test	650°C
Driver Failure Rate	1% at 5,000hrs
Weight (kg/pc)	1.02

Electrical Supply	
Frequency (Hz)	50 / 60
Voltage (V)	220-240
AC/DC	AC

Mechanical Properties	
Housing Material	Aluminum
Optical Material	PC

Application Conditions	
Operating Temperature	-10~+40°C
Application Temperature	+25°C
Storage Environment	-25~+50°C



Features

- Patented light spectrum optimization
- Reduced IR radiation
- Tilt 180°, rotate 355°
- Multiple beam angle options: 10°, 15°, 20°, or 30°
- Energy efficient

Benefits

- Showcases the freshness of meat, baked goods or vegetables
- Minimal heat transfer preserves food
- Light where you need it
- Accommodate different display sizes and ceiling heights
- Up to 50% energy savings compared to CDM

Application



Specification

Order Name	Power (W)	Power Factor	Lumen (lm)	Efficacy (lm/W)	Input Current (mA)	Beam Angle (°)	CRI (Ra)	UGR	Light Spectrum	Lifetime (L70B50)
TR30WFM-WH	30	0.95	1700	57	150	30	>90	16	Light Spectrum for Fresh Meat	30Khrs
TR30WVF-WH	30	0.95	1700	57	150	30	>90	16	Light Spectrum for Fruit/Vegetable	30Khrs
TR30WBR-WH	30	0.95	1500	50	150	30	>90	16	Light Spectrum for Bakery	30Khrs
TR45WFM-WH	45	0.95	2300	51	230	30	>90	16	Light Spectrum for Fresh Meat	30Khrs
TR45WVF-WH	45	0.95	2800	62	230	30	>90	16	Light Spectrum for Fruit/Vegetable	30Khrs
TR45WBR-WH	45	0.95	2800	62	230	30	>90	16	Light Spectrum for Bakery	30Khrs
TR45WVF-BK	45	0.95	2800	62	230	30	>90	16	Light Spectrum for Bakery	30Khrs

Dimensional Drawing

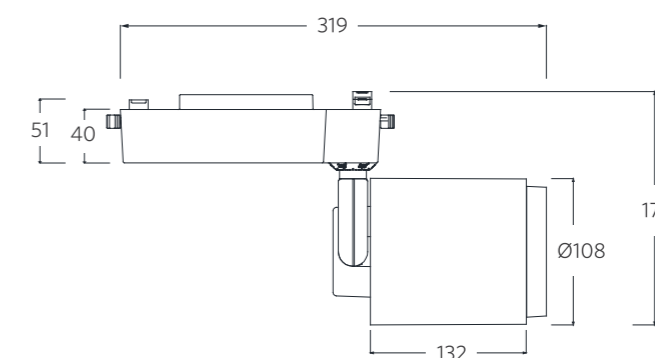

30W/45W

Packaging Information

Order Name	Single Box(1pc/box)		Packaging Unit(8pcs/unit)	
	Dimensions(mm) (LxWxH)	Gross Weight (kg)	Dimensions(mm) (LxWxH)	Gross Weight (kg)
TR30WFM-WH	222x180x122	1.40	510x375x245	11.20
TR30WVF-WH	222x180x122	1.40	510x375x245	11.20
TR30WBR-WH	222x180x122	1.40	510x375x245	11.20
TR45WFM-WH	222x180x122	1.40	510x375x245	11.20
TR45WVF-WH	222x180x122	1.40	510x375x245	11.20
TR45WBR-WH	222x180x122	1.40	510x375x245	11.20
TR45WVF-BK	222x180x122	1.40	510x375x245	11.20

Photometric Data

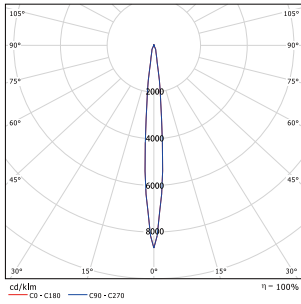

10°(30W)

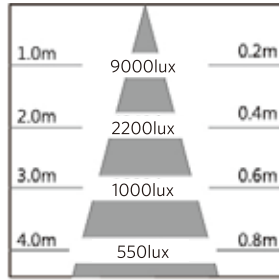

For Fresh Meat, Ra>90, R9=93

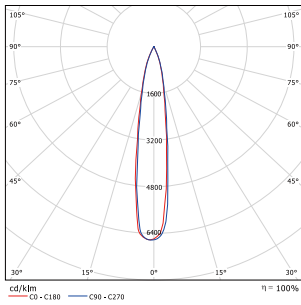
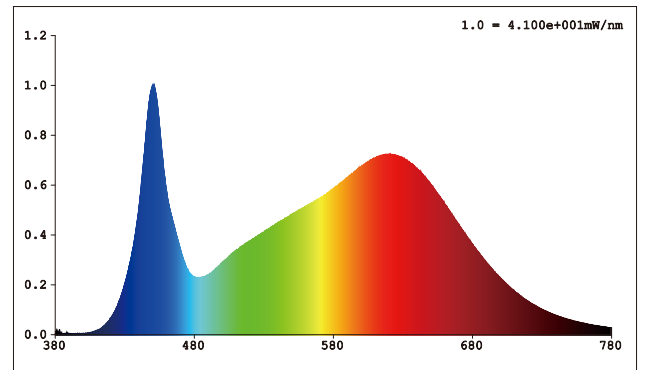

15°(45W)

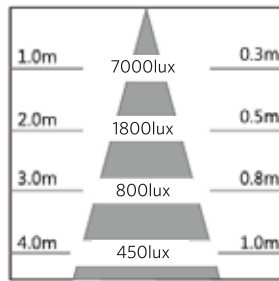

For Bakery, Ra>90, R10=93

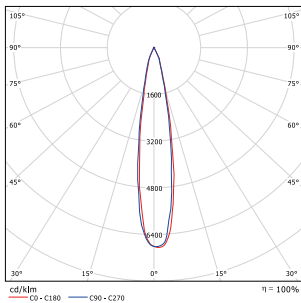
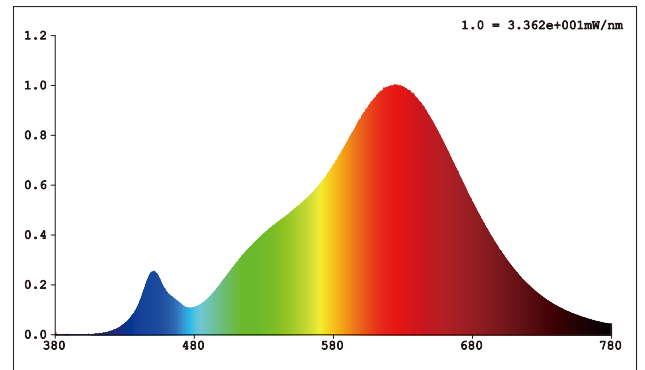

20°(30W/45W)

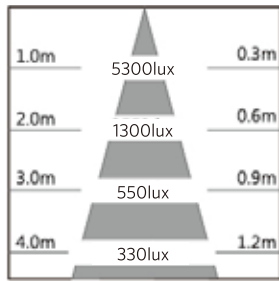

For Fruit and Vegetable, Ra>90, R11=92

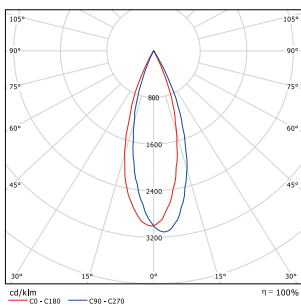
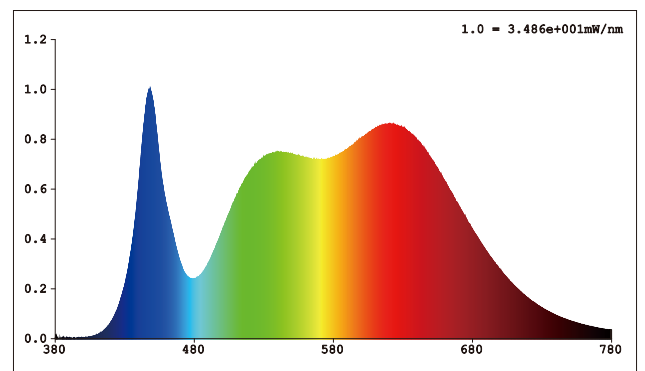

30°(30W/45W)

